

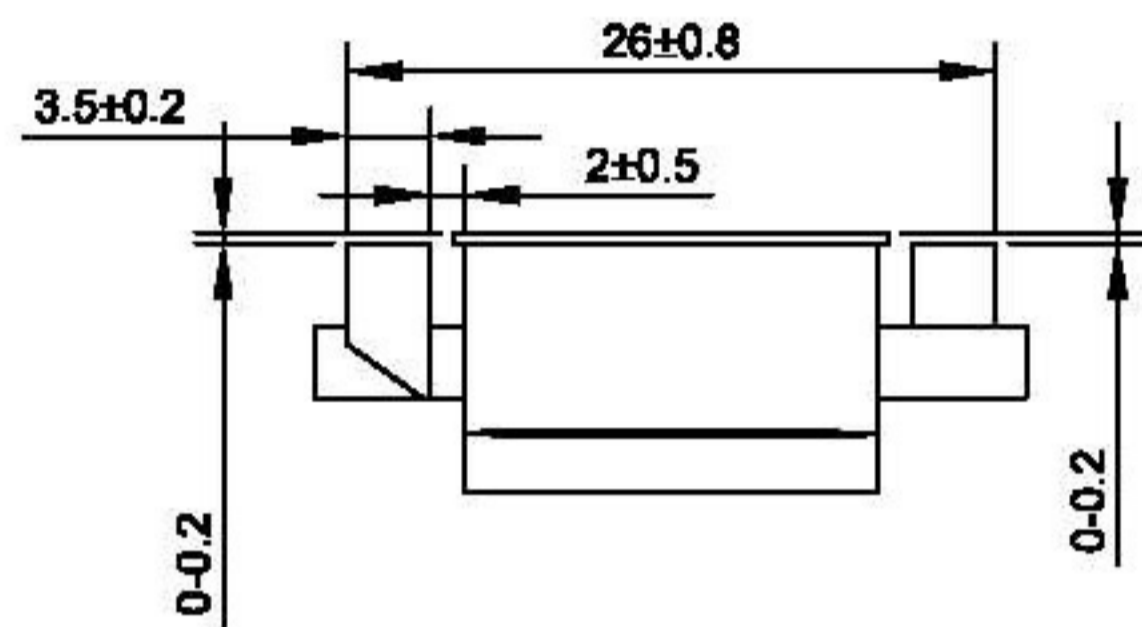

SHENZHEN JQL ELECTRONICS CO.,LTD

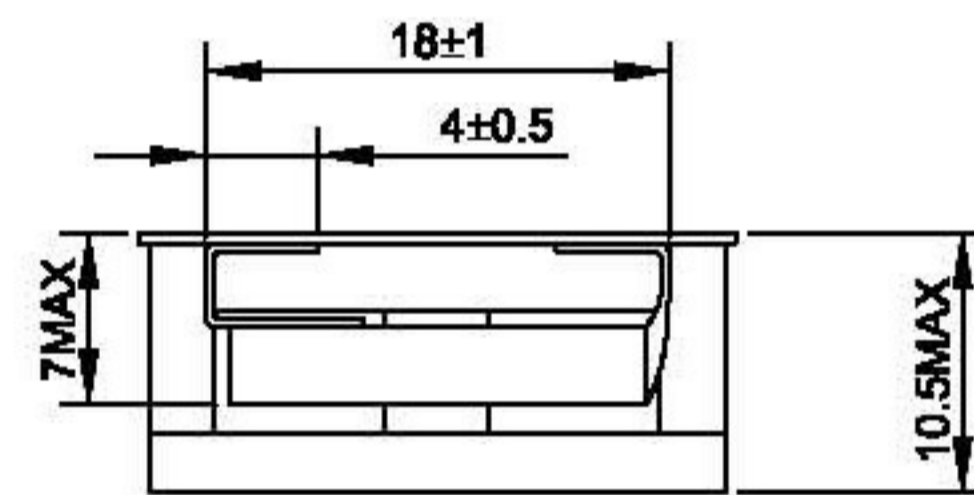

FRONT VIEW



SIDE VIEW

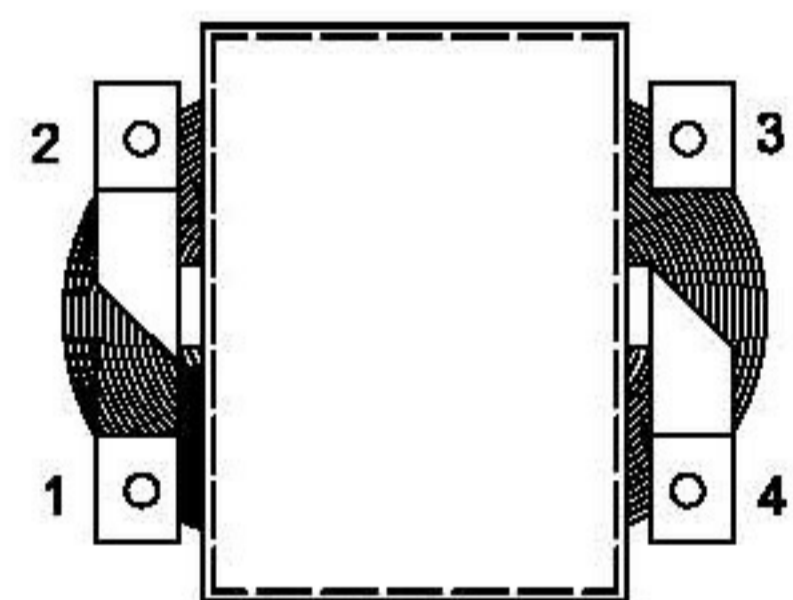

BOTTOM VIEW

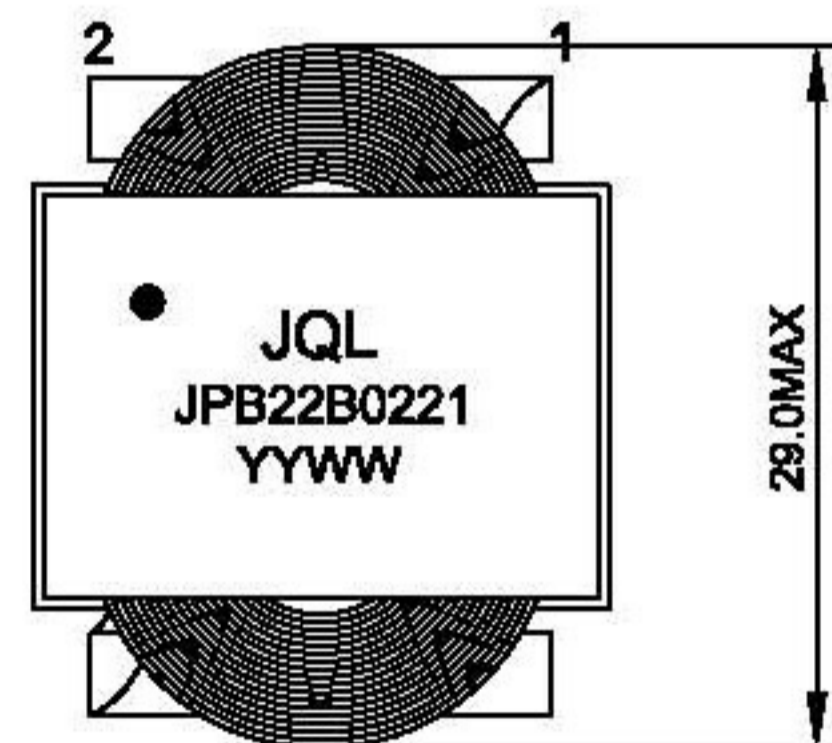

TOP VIEW

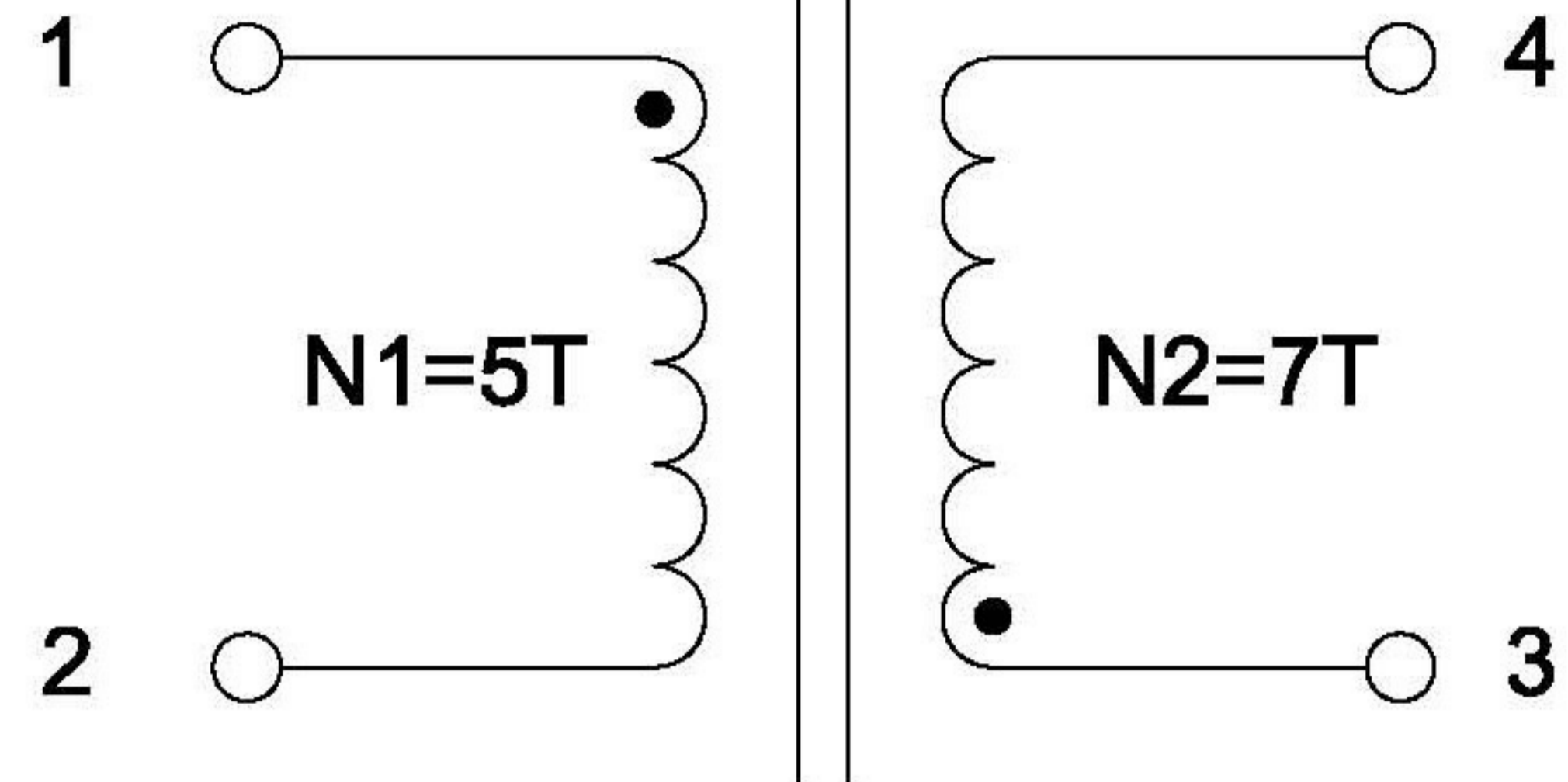

TEST NOTES

UNLESS OTHERWISE SPECIFIED, TESTING IS PERFORMED AT 100 KHz, 1000mV, 25°C ± 5°C.

1. TURNS RATIO AND POLARITY:(100% TEST)
(1-2)/(3-4)= 5:7
2. INDUCTANCE:(100% TEST)
(1-2)=130.0uH MIN
3. LEAKAGE INDUCTANCE:(SAMPLE TEST)
(1-2) WITH (3-4)SHORTED= 0.5uH MAX
4. DCR:(SAMPLE TEST)
(1-2)= 8.0mΩ MAX
(3-4)= 10.0 mΩ MAX
5. HI-POT:(100% TEST)
PRI-SEC : DC 1.5KV/1mA/60sec
PRI-CORE: DC 1.5KV/1mA/60sec
SEC-CORE: DC 0.5KV/1mA/60sec